

VIEW V  
SCALE: 1/1

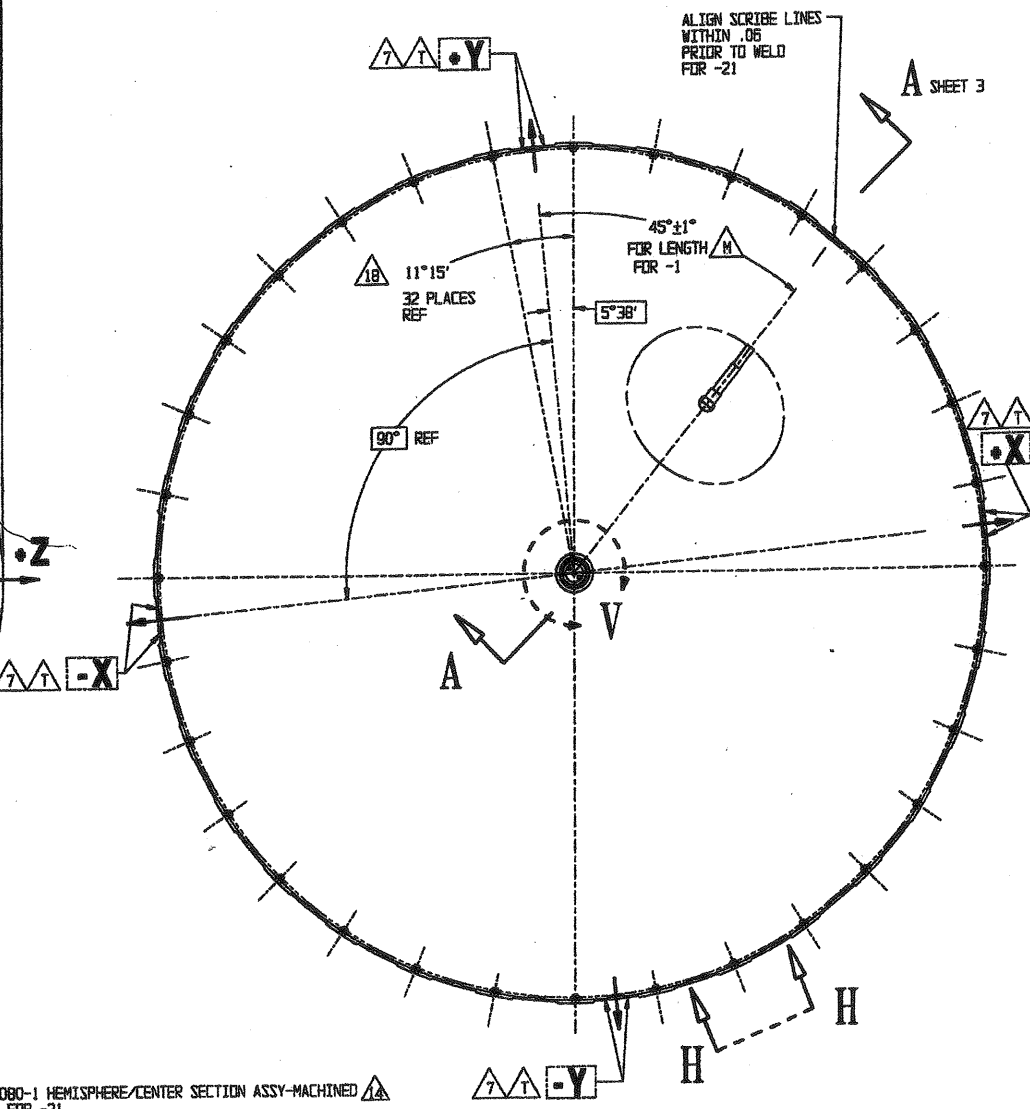

- (-21) TANK, WELDMENT 1 REQD FOR -11
- (-11) TANK ASSY 1 REQD FOR -1

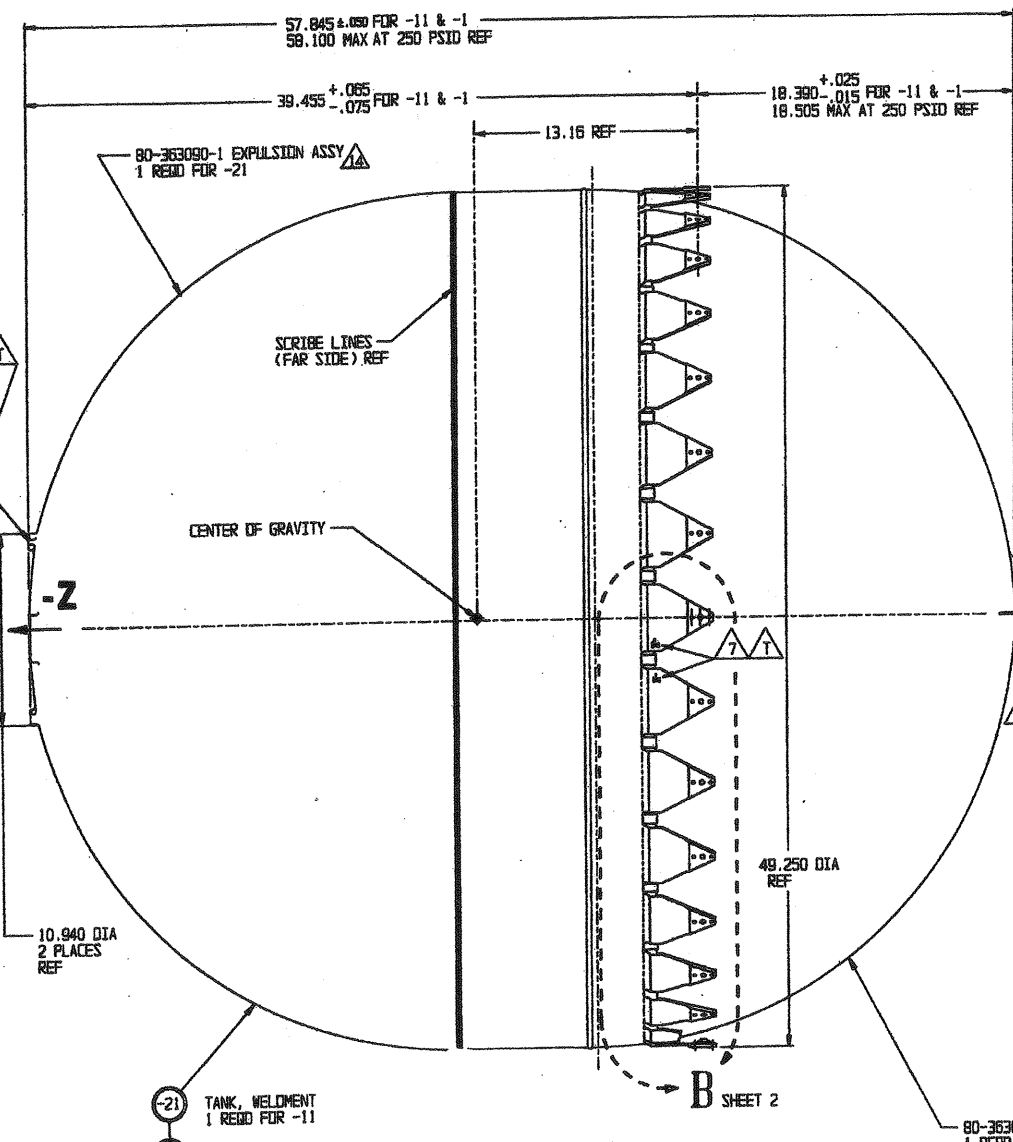
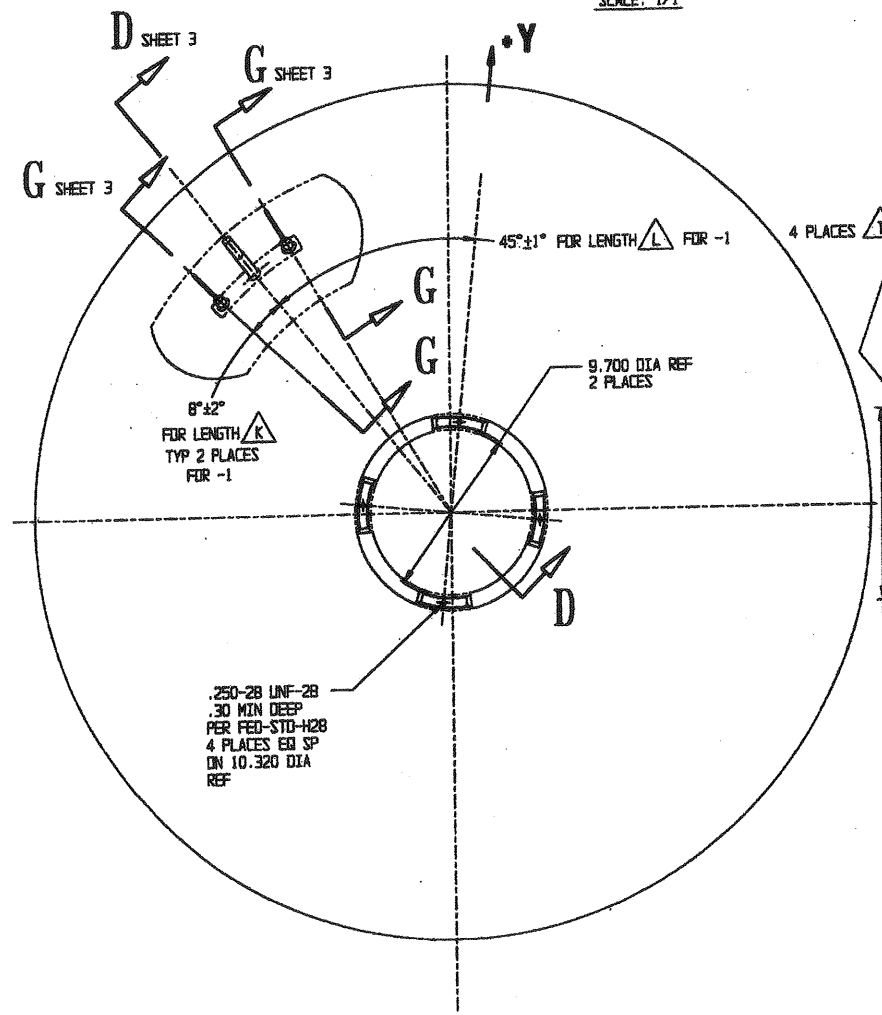
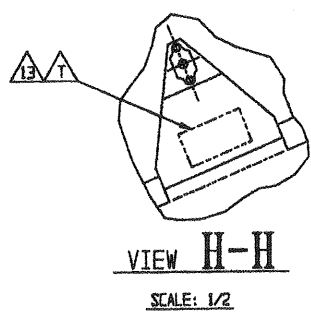

Pressure Systems, Inc.  
LOS ANGELES, CALIFORNIA

PROPELLANT TANK ASSY

CODE IDENT NO.	SIZE	REV.
18229	E	80363 B
SCALE 1/4	SHEET 1 OF 3	

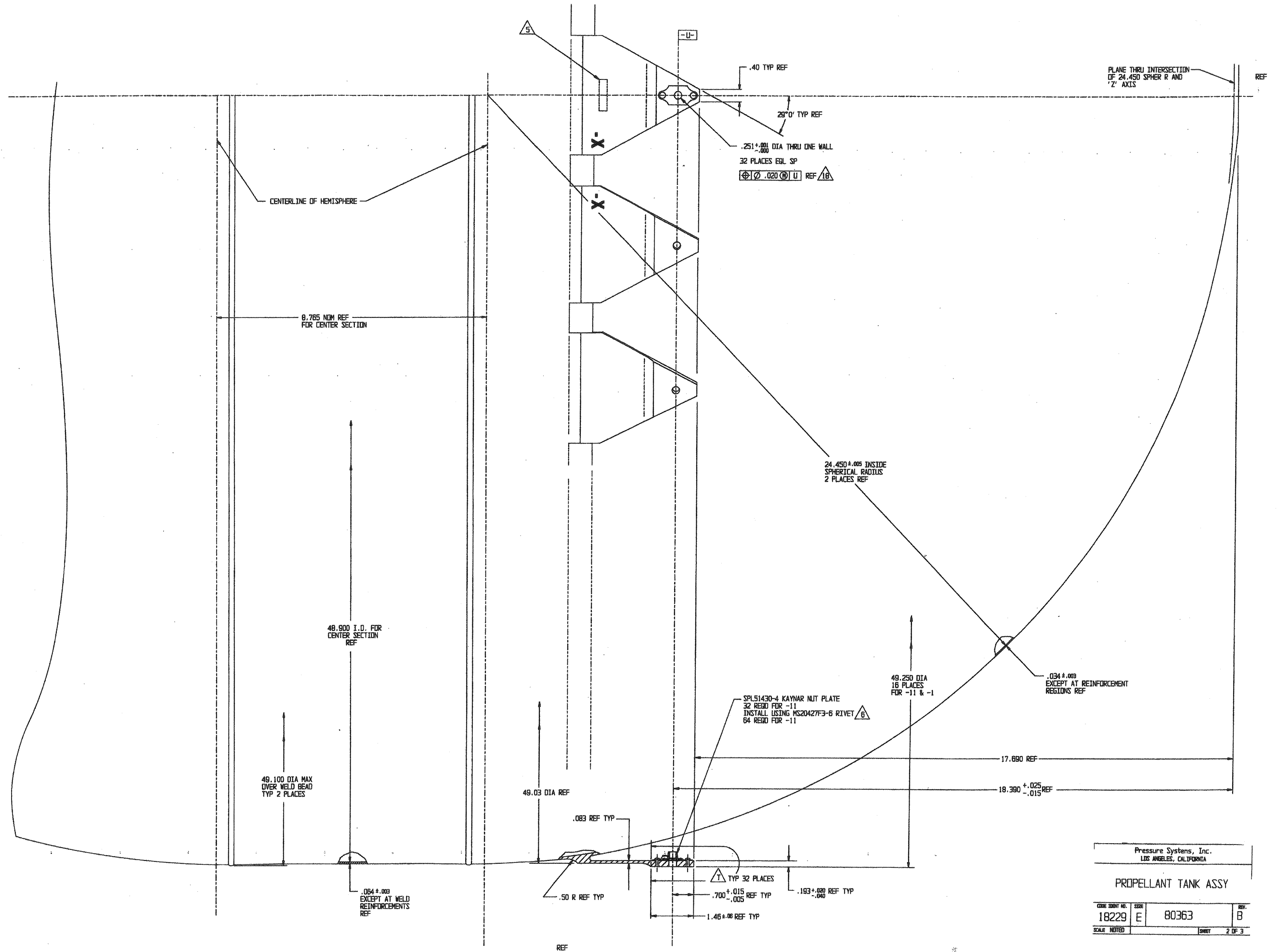

Pressure Systems, Inc. LOS ANGELES, CALIFORNIA			
PROPELLANT TANK ASSY			
CODE IDENT NO. 18229	SIZE E	REV. 80363	REV. B
SCALE NOTED	SHEET		2 OF 3

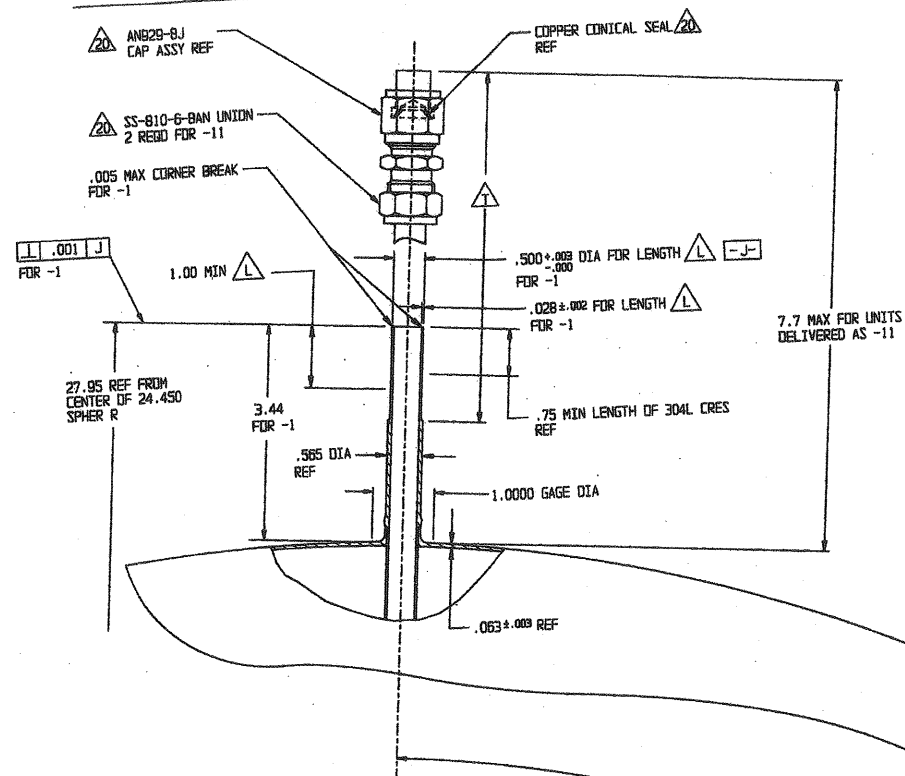

SECTION D-D SHEET 1  
SCALE: 1/1

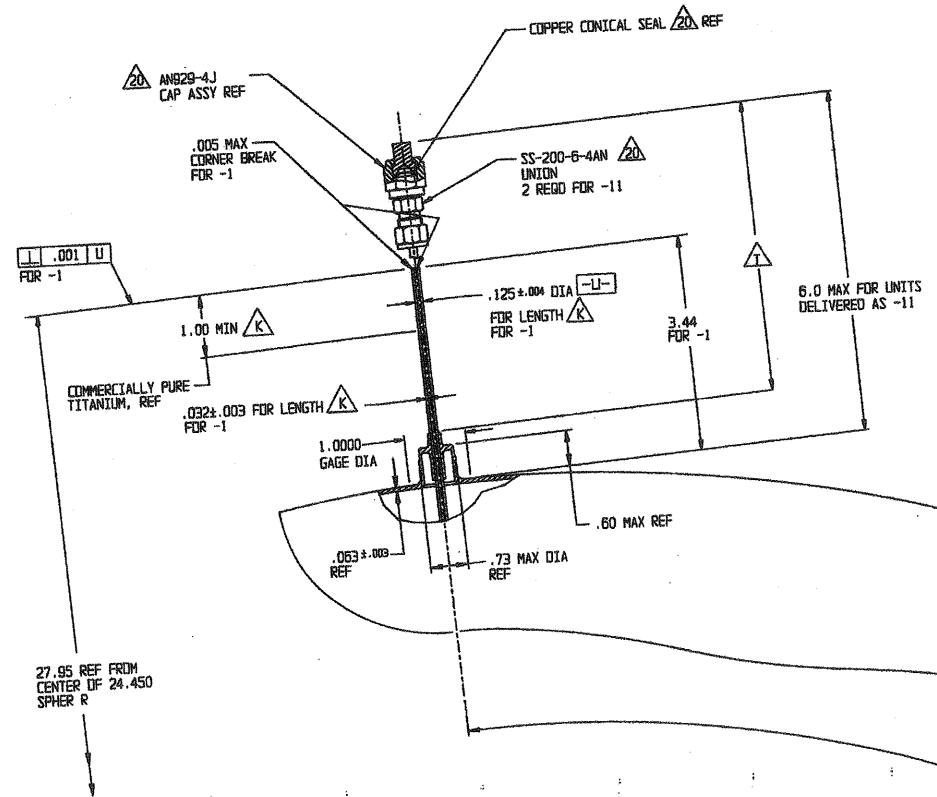

SECTION G-G SHEET 1  
SCALE: 1/1  
TYP 2 PLACES

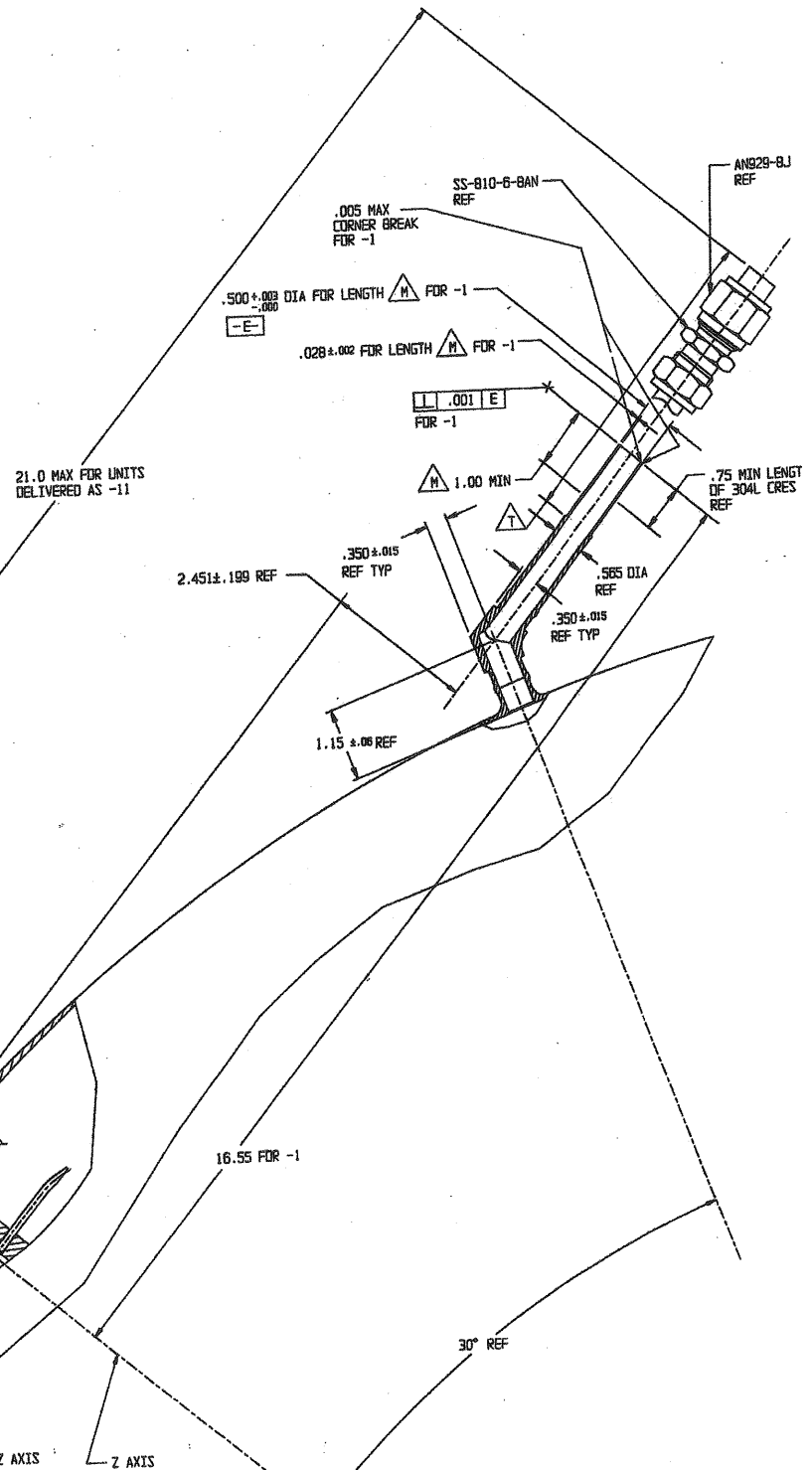

Pressure Systems, Inc.  
LOS ANGELES, CALIFORNIA

PROPELLANT TANK ASSY

CODE IDENT NO.	SIZE	REV.
18229	E	80363
SCALE NOTED	SHEET	3 OF 3